

8800 N

AC axial compact fan



Nominal data

Type	8800 N	
Phase		1~
Nominal voltage	VAC	115
Frequency	Hz	60
Speed	min ⁻¹	2500
Power input	W	11.0
Min. ambient temperature	°C	-10
Max. ambient temperature	°C	70
Air flow	m ³ /h	47
Sound power level	B	4.3
Sound pressure level	dB(A)	28

ml = max. load · me = max. efficiency · fa = running at free air · cs = customer specs · cu = customer unit
Subject to alterations

Technical features

General description	AC voltage fan with external rotor shaded-pole motor. Protected from overload by impedance protection. Fan housing and fan impeller made of metal. Air exhaust over bars. Rotational direction clockwise looking at rotor. Electrical connection to 2 single strands. Strand ends bared and tin-plated. Fan housing with grounding lug and tapping screw M4 x 8 (TORX). Mass 490 g. Please note our new ACmaxx series. With identical fastening dimensions and voltages, this series achieves higher energy efficiency.
Mass	0.490 kg
Dimensions	80 x 80 x 38 mm
Material of impeller	Metal
Housing material	Metal
Direction of air flow	Air exhaust over bars
Direction of rotation	Right, looking at rotor
Bearing	Sintec sleeve bearing system
Lifetime L10 at 40 °C	55000 h
Lifetime L10 at maximum temperature	27500 h
Connection line	2 single strands AWG 28, TR 64
Motor protection	Protected from overload using impedance protection
Approval	VDE, CSA, UL, CE

8800 N

AC axial compact fan

Product drawing

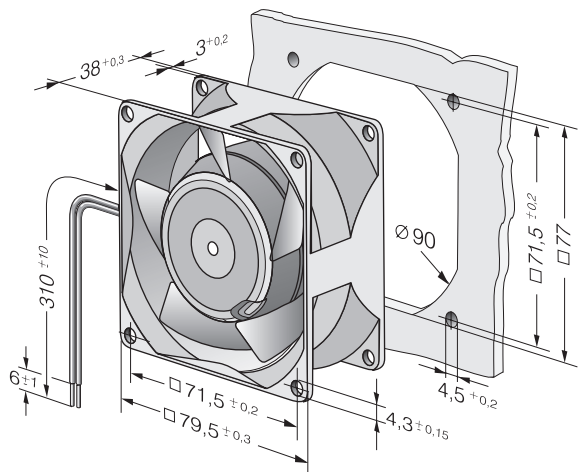

8800 N

AC axial compact fan

Charts: Air flow

