

4656 N

AC axial compact fan



Nominal data

Type	4656 N	
Phase		1~
Nominal voltage	VAC	230
Frequency	Hz	50
Speed	min ⁻¹	2650
Power input	W	19.0
Min. ambient temperature	°C	-40
Max. ambient temperature	°C	85
Air flow	m ³ /h	160
Sound power level	B	5.5
Sound pressure level	dB(A)	47

ml = max. load · me = max. efficiency · fa = running at free air · cs = customer specs · cu = customer unit
Subject to alterations

Technical features

General description	<p>AC voltage fan with external rotor shaded-pole motor. Protected from overload by impedance protection.</p> <p>Fan housing and fan impeller made of metal.</p> <p>Inlet over bars. Rotational direction clockwise looking at rotor. Types 4890 N and 4840 N air exhaust over bars.</p> <p>Electrical connection to 2 flat plugs 3.0 x 0.5 mm.</p> <p>Impeller with 3 or 5 blades, see note for fan type.</p> <p>Optionally available:</p> <p>variants with reinforced mounting flanges and single strands that are brought out.</p> <p>Fan housing with grounding lugs with M4 and UNC thread.</p> <p>Mass 550 g.</p> <p>Please note our new ACmaxx series. With identical fastening dimensions and voltages, this series achieves higher energy efficiency.</p>
Mass	0.550 kg
Dimensions	119 x 119 x 38 mm
Material of impeller	Metal
Housing material	Metal
Direction of air flow	Inlet over bars
Direction of rotation	Right, looking at rotor
Bearing	Ball bearings
Lifetime L10 at 40 °C	37500 h
Lifetime L10 at maximum temperature	15000 h
Connection line	2 flat plugs 3.0 x 0.5 mm. Housing with grounding lugs for screw M4 and UNC.
Motor protection	Protected from overload using impedance protection
Approval	VDE, CSA, UL, CE

4656 N

AC axial compact fan

Product drawing

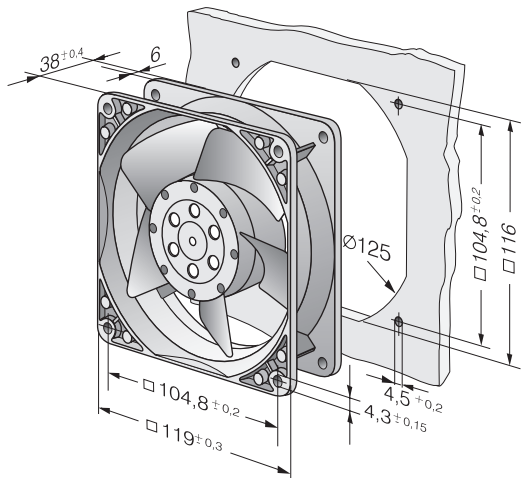

Charts: Air flow

